

STEEL DRUM 10L

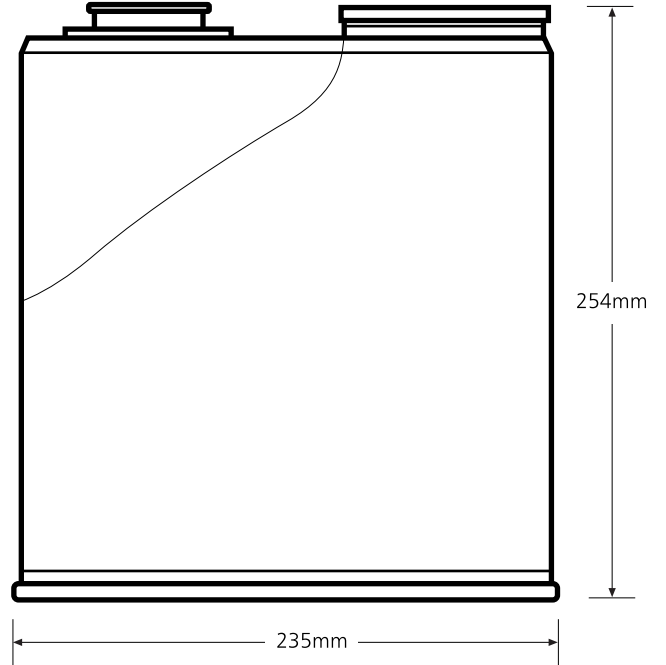

Container

Size	Closure	Weight	Drop Height	Steel Dims (Body)	UN Approval	No. Pallet
10L	G2 & G ³ / ₄ Tri-Sure steel Closures	1.8kg	1.8m	0.6mm	1A1/X/400/**/GB/5322	125

Applications:

Chemical, Paint, and Petroleum and Food Industries.

Nexus Packaging Ltd.

7 Centurion Business Park, Shields Road, Glasgow, G41 1HH

Tel: 0141 429 2525 | Fax: 0141 429 2060 | Email: admin@nexpack.co.uk

REGISTERED IN SCOTLAND: No. SC262044 | VAT No. 829 6449 83